

1.5A, 3.0-25.0V H-Bridge Driver

Description

The SA8343 is one channel H-Bridge driver IC, it provides integrated motor-driver solution for toys, robotics, consumer products and other low voltage or battery-powered motion control applications.

The SA8343 maximum operational voltage is 25.0V. It can supply up to 1.5A of output continuous current and 3.5A of output peak current. There is internal shutdown function for over-temperature protection and over-current protection ($I_{OCP} = 4.5\text{ A}$).

Package material is Pb-Free Product & RoHS compliant for the purpose of environmental protection and for sustainable development of the earth.

Features

- Operation voltage up to 25.0V
- Continuous current output up to 1.5A
- Peak current up to 3.5A
- $R_{DS(on)}$: 350-m Ω (HS + LS)
- Support PWM control
- Over current protection
- Over temperature protection
- UVLO protection
- Low standby current
- Low quiescent current
- SOP8 package

Application

- Robotics (R/C servo, Sweeping robot)
- Toys (R/C car, R/C aircraft)
- Any relevant DC motor applications.

SA8343 Package & Simplified Application

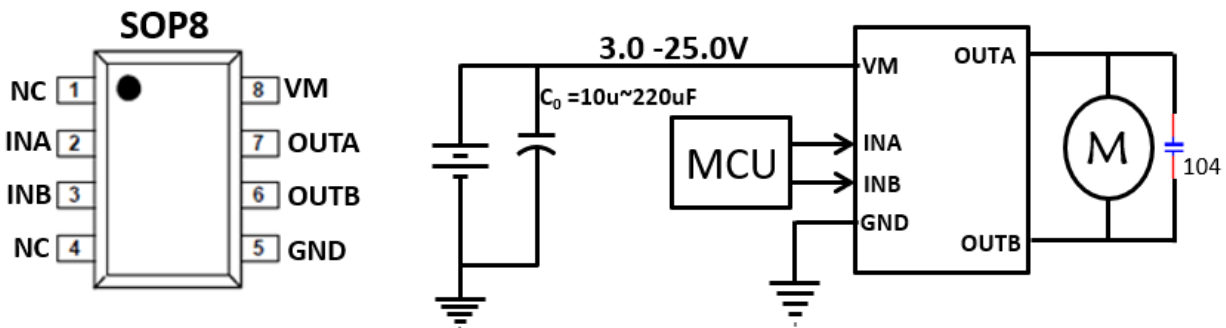

Device Information

Part No.	Package	Quantity	Operation Temp.
SA8343	SOP8	4000	-40~85 °C

1.5A, 3.0-25.0V H-Bridge Driver

Package

SOP8

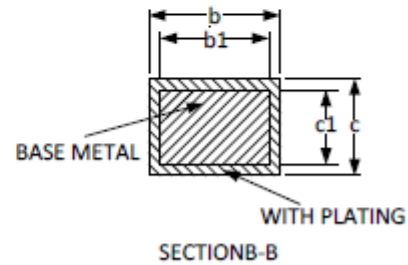
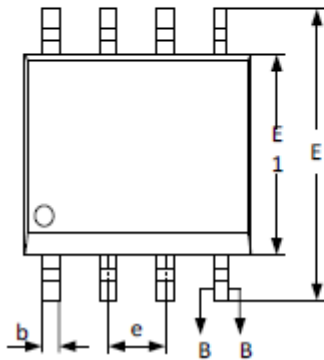
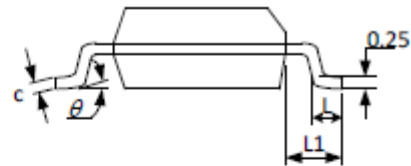
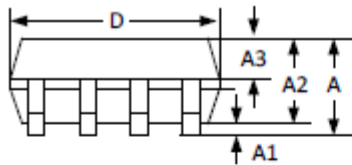

SYMBOL	MILLIMETER		
	MIN	NOM	MAX
A	--	--	1.77
A1	0.08	0.18	0.28
A2	1.20	1.40	1.60
A3	0.55	0.65	0.75
b	0.39	--	0.48
b1	0.38	0.41	0.43
c	0.21	--	0.26
c1	0.19	0.20	0.21
D	4.70	4.90	5.10
E	5.80	6.00	6.20
E1	3.70	3.90	4.10
e	1.27BSC		
L	0.50	0.65	0.80
L1	1.05BSC		
θ	0	--	8°

1.5A, 3.0-25.0V H-Bridge Driver

IMPORTANT NOTICE

Syta Technology Corporation (Sytatek) reserves the right to make corrections, modifications, enhancements, improvements, and other changes to its products and to discontinue any product without notice at any time.

Sytatek cannot assume responsibility for use of any circuitry other than circuitry entirely embodied in a Sytatek product. No circuit patent licenses are implied.